

LI/MnO₂ BUTTON BATTERY

RECHARGEABLE ML3032 DATA SHEET

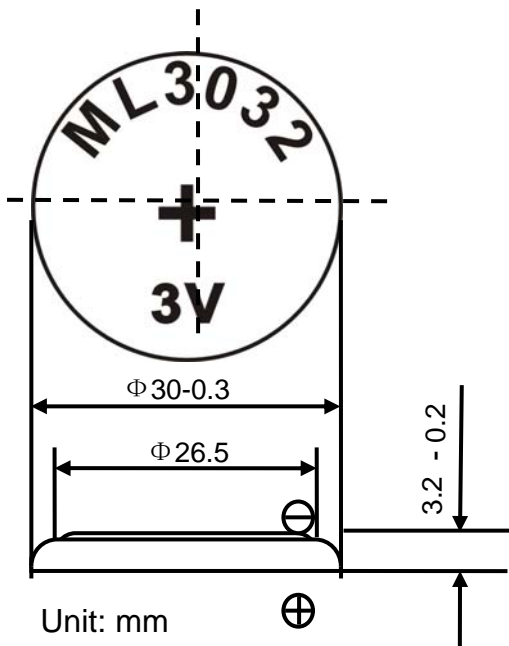

Nominal Capacity(mAh) ^{*1}		110
Nominal Voltage(V)		3.0
Standard Charge/Discharge Current(mA)		0.5
Charge/Discharge Cycle Characteristics	Discharging Depth of 10%	300
	Discharging Depth of 20%	100
Temperature Range(°C)		-20~60
Weight(g) ^{*2}		4.6
Dimensions(mm)	Diameter(D)	30
	Height(h)	3.2-0.2
	d (Negative end)	26.5

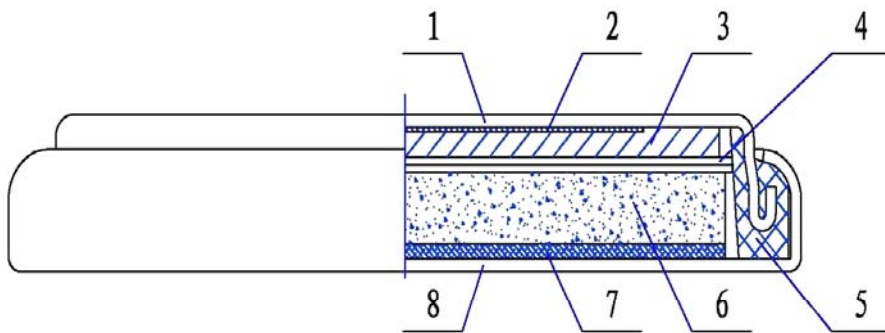

- | | | | |
|-----------------|-----------------------------|------------------------------|---------------|
| 1、负极壳 | 2、负极集流网 | 3、负极锂片 | 4、隔膜 |
| 5、密封胶圈 | 6、正极片 | 7、正极集流网 | 8、正极壳 |
| 1、Cathode Shell | 2、Cathode collector net | 3、Cathode (slice of lithium) | 4、Septum |
| 5、Gasket | 6、Anode(MnO ₂) | 7、Anode collector net | 8、Anode shell |



Add.: Block B1, Dashi Town, Panyu District, Guangzhou C, PRC Tel: 0086-20-61906348 Fax: 0086-20-61906358
<http://www.gmbattery.com> email: info@gmbattery.com